

MANISCOPIIC

MLT 627
TURBO
"Compact"





- Maximum lifting height : 5.50 m
- Capacity : 2700 kg
- Maximum forward reach : 3.20 m
- Torque convertor

STANDARD OR
LOW PROFILE CAB
VERSIONS AVAILABLE

 **MANITOU**

MLT 627 20" TURBO

 **Lifting capacity**2700 kg
at 500 mm from forks heels.

 **Lifting height**5.50 m
Times : unladen/loaded (in s)
Lifting6,8/7,1
Lowering4.8/4.7
Boom extension.....4,5/4,6
Boom retraction.....2,2/2,2
Time unladen (in s)
Crowd3,5
Dump2,7

 **Tyres**
400/70-20 T37

 **Forks (mm)**
Length.....1200
Width.....125
Carriage rotation.....154°

 **Oil bath multidisc brakes on front/rear axle**

 **Perkins engine**
Type.....1104C.44 Turbo
Cylinders4 cyl./4400 cm³
Power (ISO/TR 14396).....101 HP/74.5 kw
Maximum torque.....412 Nm at 1400 tr/mn
Direct injection
Water cooling

 **Transmission**.....Torque Convertor
Electro - hydraulic reversing shift
4 speeds forward and reverse
Maximum travel speed.....30 km/h

 **Hydraulics**
Lifting/tilting pump :
gear type105 l./mn - 250 bars
Flow divider with priority to steering

 **Capacities**
Cooling system.....25 l.
Engine oil8.5 l.
Hydraulic oil.....98 l.
Transmission oil14.5 l.
Fuel tank104 l.

 **Weight unladen (with forks)** :5935 kg
Overall width2.01 m
Overall height
MLT 627 T compact2.06 m
MLT 627 T2.21 m
Turning radius (outside wheels)3.70 m
Overall length4.69 m
Ground clearance0.36 m
Drawbar pull :
MLT 627 T/MLT 627 T compact7100 daN

"TAILOR MADE" DIMENSIONS

Overall width : 2.01 m

Overall length : 4.69 m

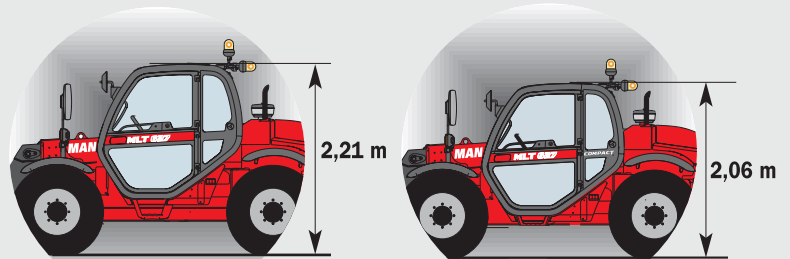

STANDARD LEVEL CAB

LOW PROFILE CAB
"Compact" version

Reach at maximum height : 0,90 m

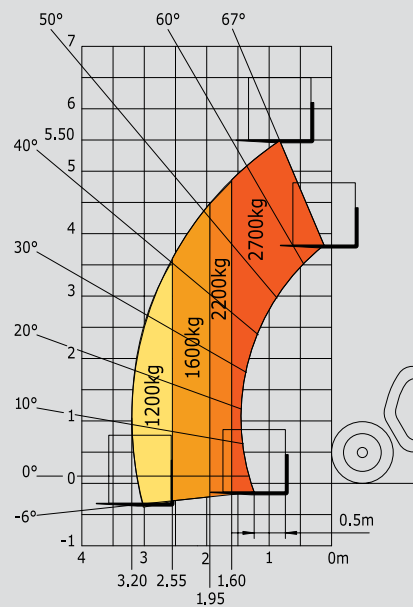

Under EN 1459 annexe B

MLT 627 T 20"	
A	1200
B	2520
C	1307
C1	1260
D	4687
D1	4640
D2	3870
E	5887
F	1600
G	400
I	860
J	866
K	1260
L	45
O	125
P2	41°
P3	39°
R	3385
S	7482
T	3520
U1	2060
U2	2320
V	4770
V1	1250
V2	3700
W	2010
Y	11.8°
Z	142.3°

mm

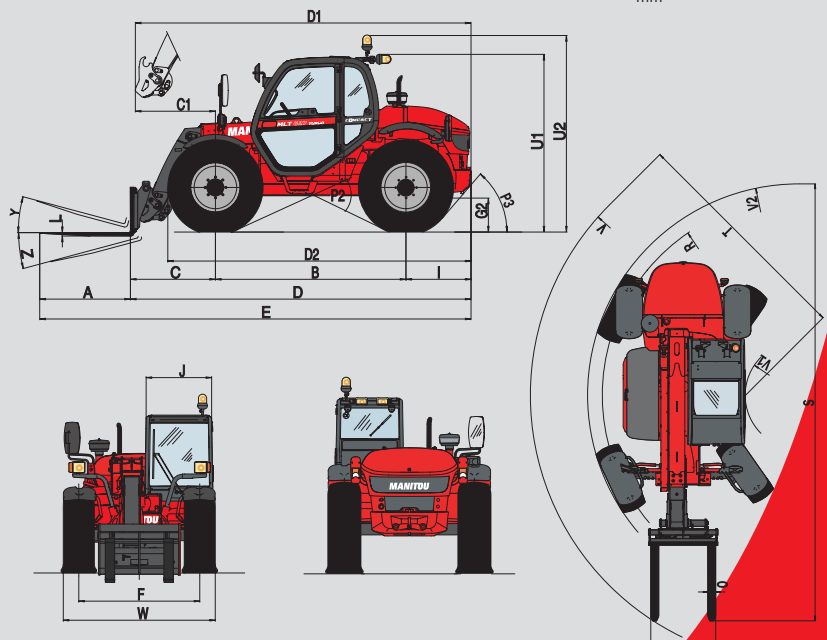

This publication in no way constitutes an offer and the company reserves the right to alter specification without prior notice.
The MANITOU models presented in this brochure can be supplied complete with optional equipment attachments.

